

# AWS Stile & Rail Door Drawings

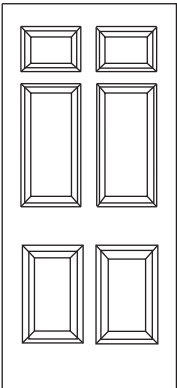

D-1

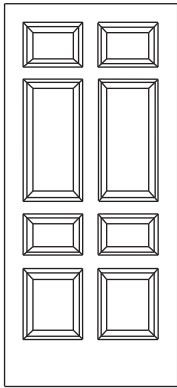

D-2

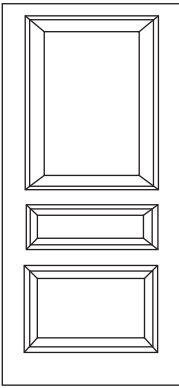

D-3

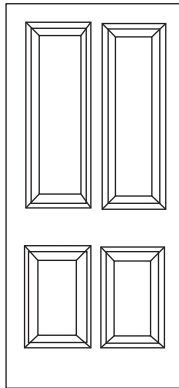

D-4

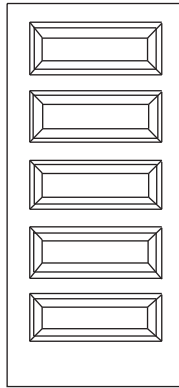

D-5

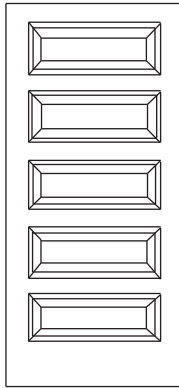

D-6

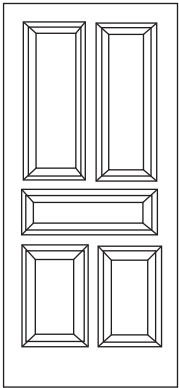

D-7

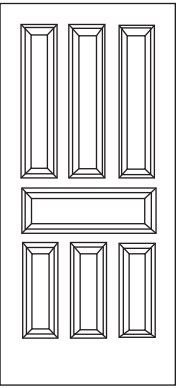

D-8

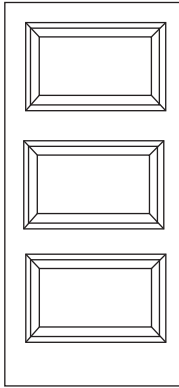

D-9

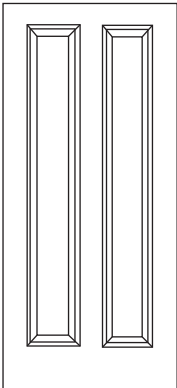

D-10

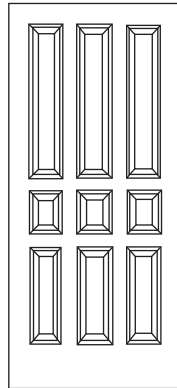

D-11

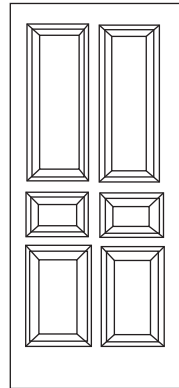

D-12

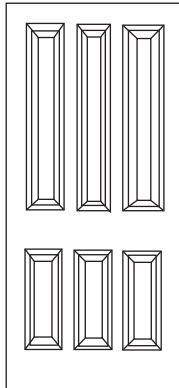

D-13

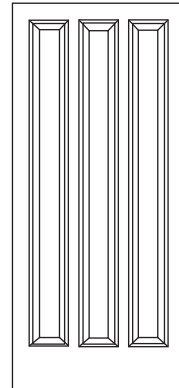

D-14

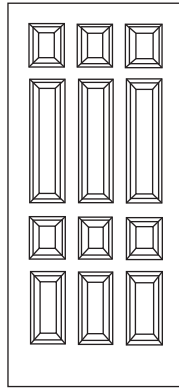

D-15

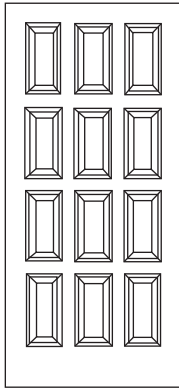

D-16

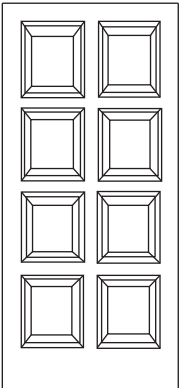

D-17

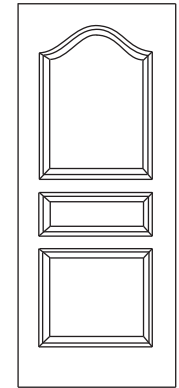

D-18

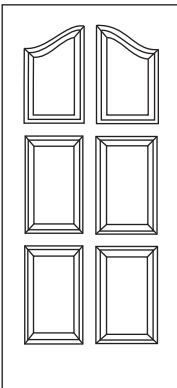

D-19

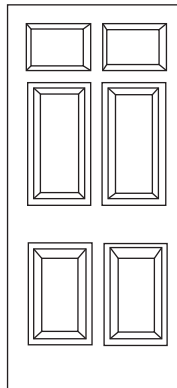

D-20

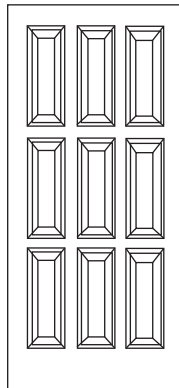

D-21

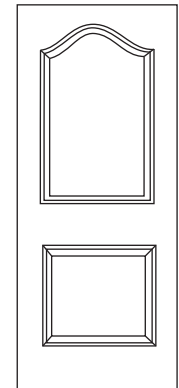

D-22

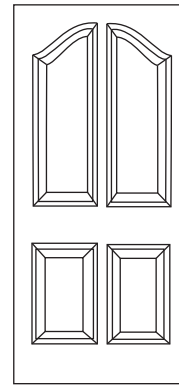

D-23

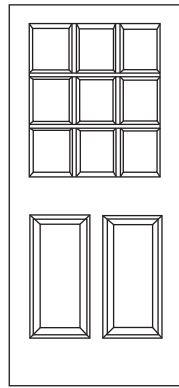

D-24

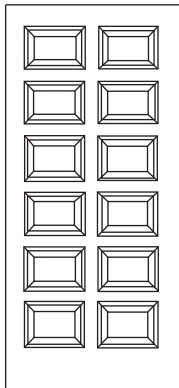

D-25

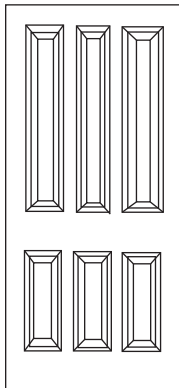

D-26

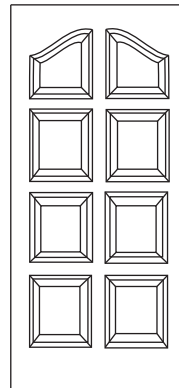

D-27

# AWS Stile & Rail Door Drawings

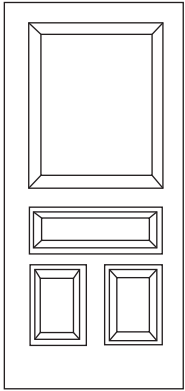

D-28

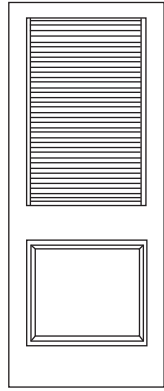

D-29

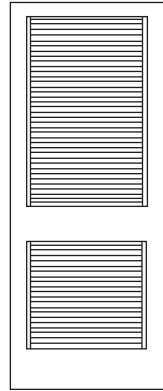

D-30

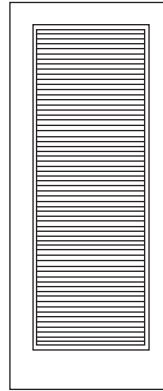

D-31

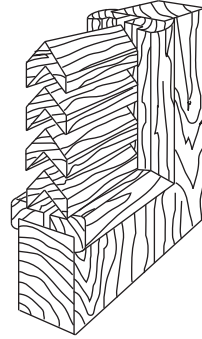

D-32

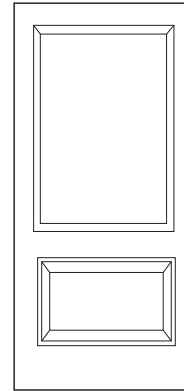

D-33

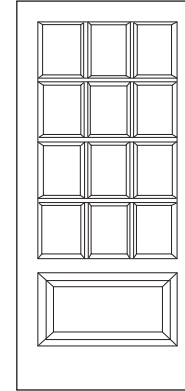

D-34

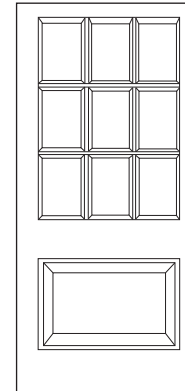

D-35

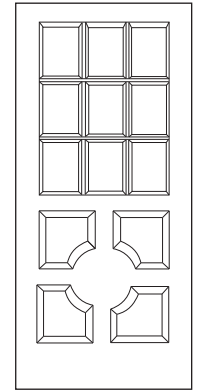

D-36

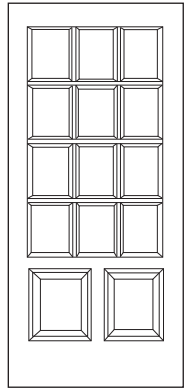

D-37

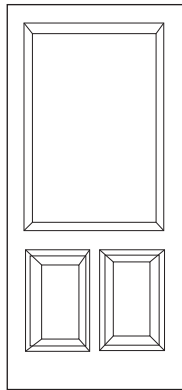

D-38

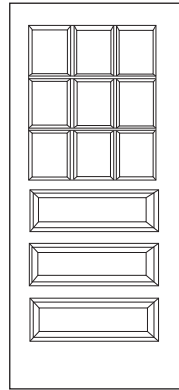

D-39

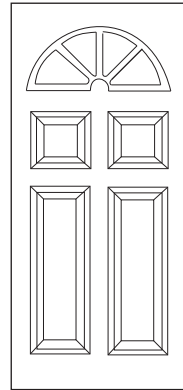

D-40

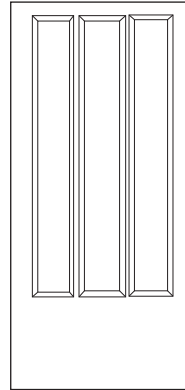

D-41

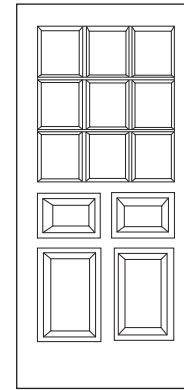

D-42

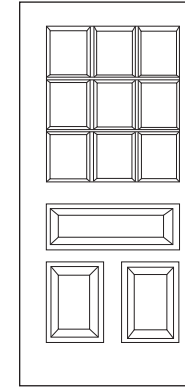

D-43

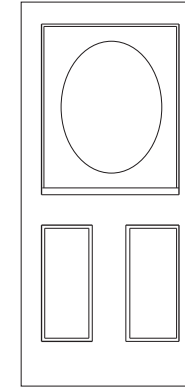

D-44

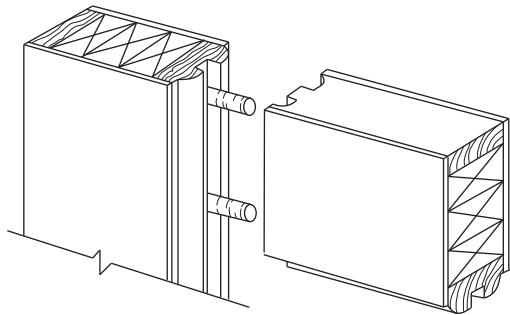

D-45

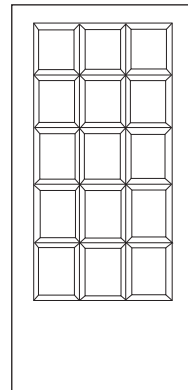

D-46

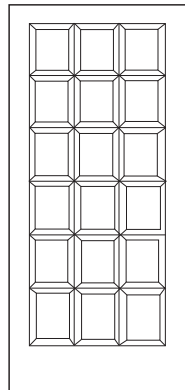

D-47

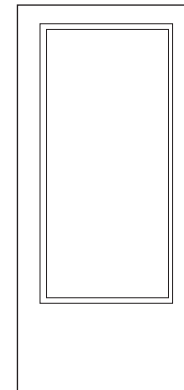

D-48

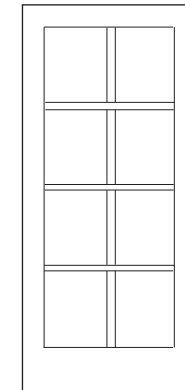

D-49

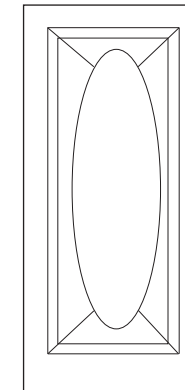

D-50

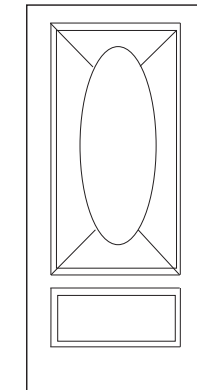

D-51

# AWS Stile & Rail Door Drawings

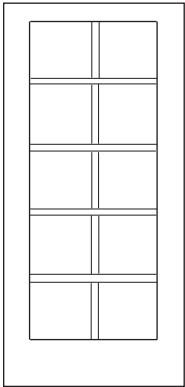

D-52

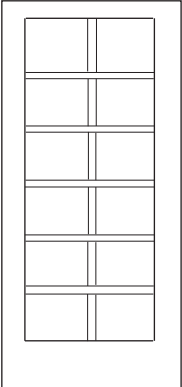

D-53

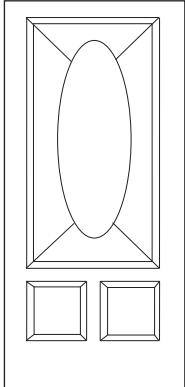

D-54

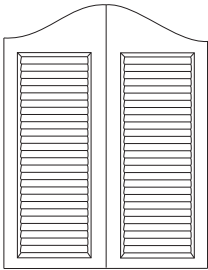

D-55